

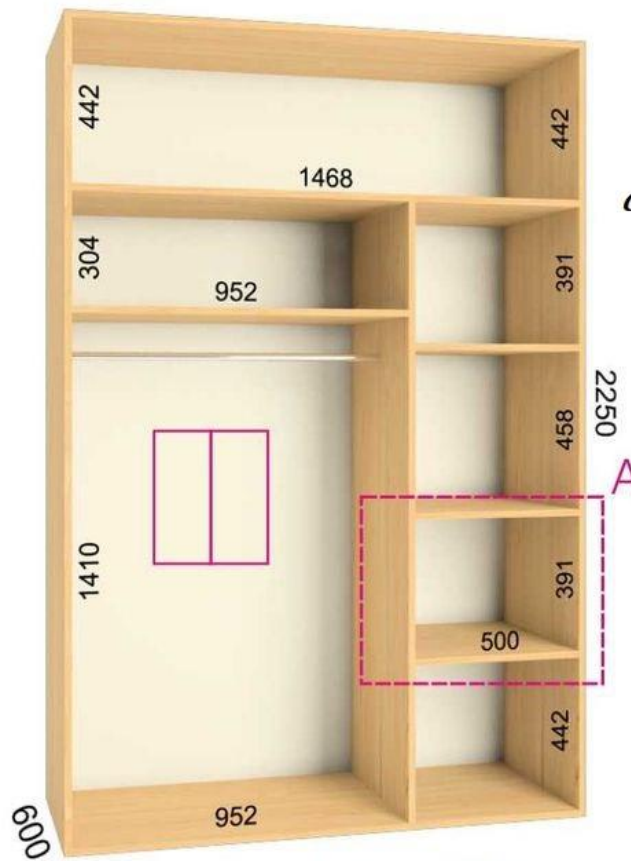

*LOS MANCHEGOS  
DE LA  
CHIQUITANIA S.R.L*

*Para consultas llamar al  
Cel.: 62116465*



*LOS MANCHEGOS  
DE LA  
CHIQUITANIA S.R.L*

*Para consulta llamar  
al Cel.: 62116465*

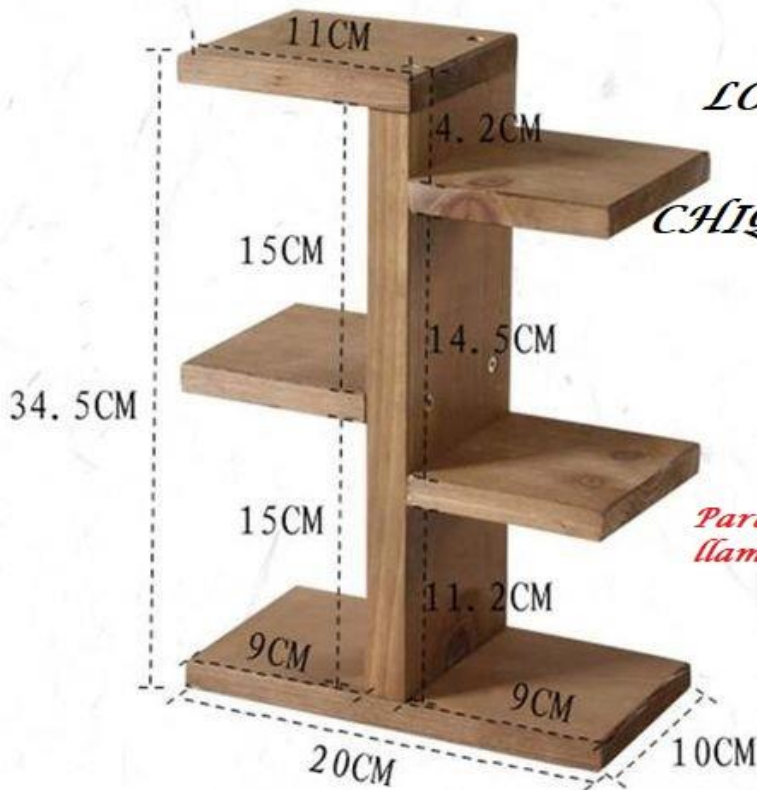

*LOS MANCHEGOS  
DE LA  
CHIQUITANIA S.R.L.*

*Para mayor informacion  
llamar al Cel.: 62116465*

*Para consultas llamar al  
Cel.: 62116465*

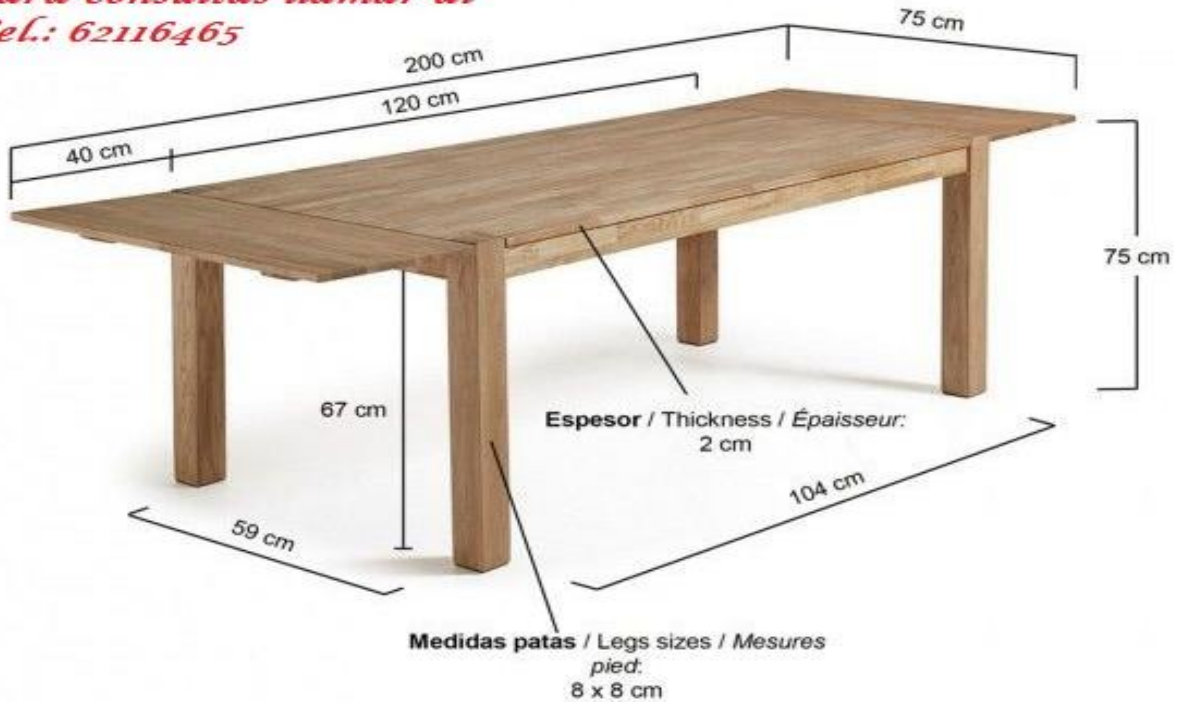

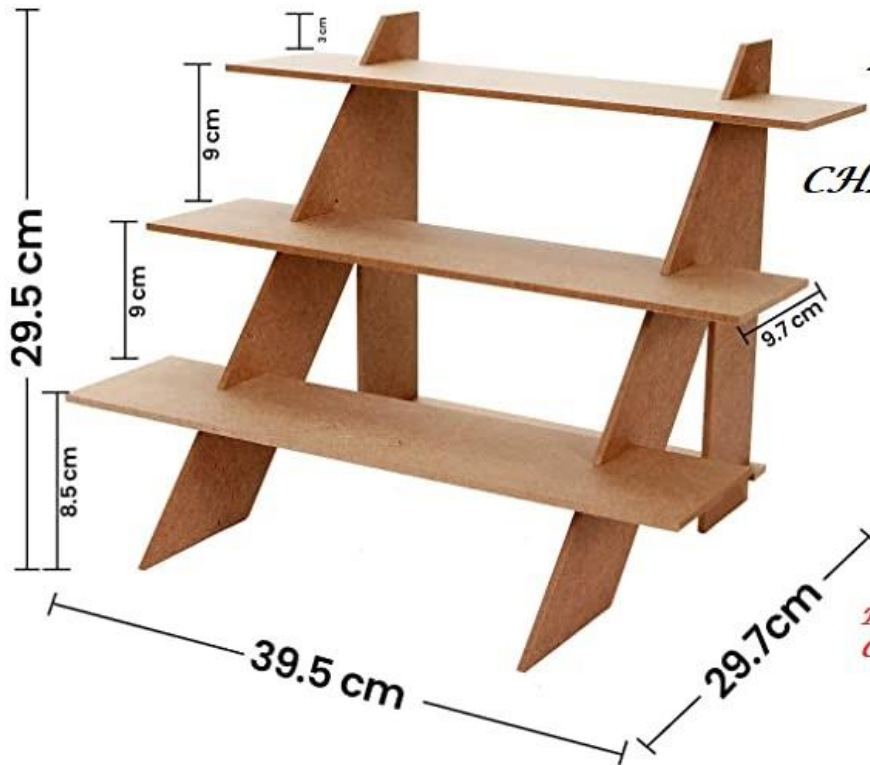

*LOS MANCHEGOS  
DE LA  
CHIQUITANIA S.R.L*

*Para consultas llamar al  
Cel.: 62116465*







## LOS MANCHEGOS DE LA CHIQUITANIA S.R.L

medidas en centímetros

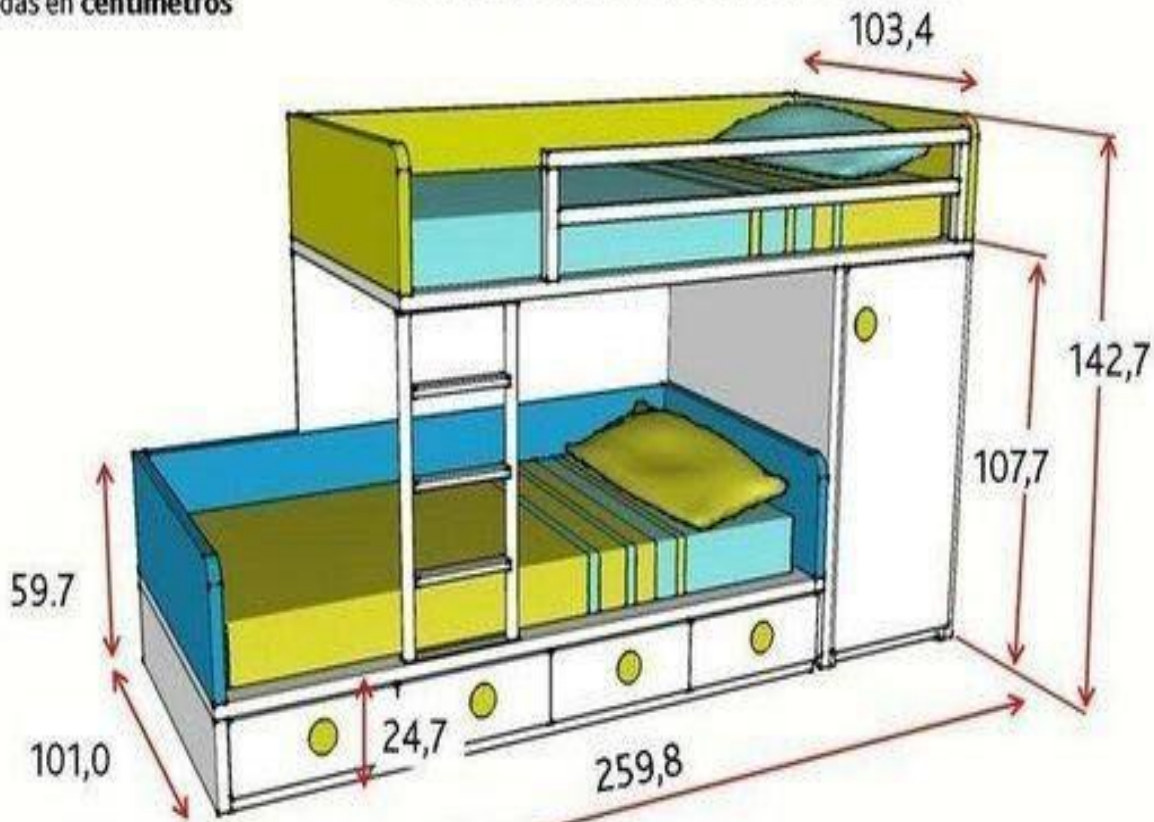

El modulo de una puerta con barra y estantes  
se puede sustituir por uno de contenedores

*Para consultas llamar al  
Cel.: 62116465*

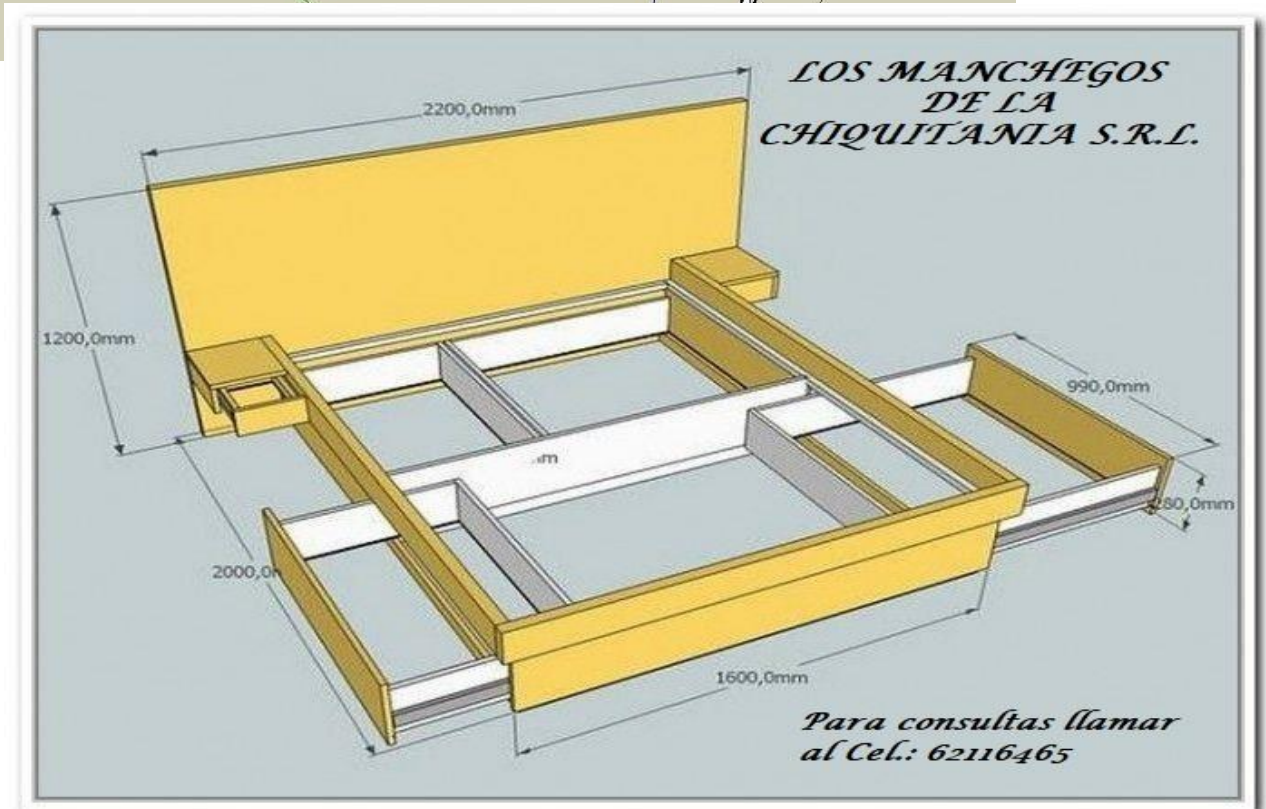
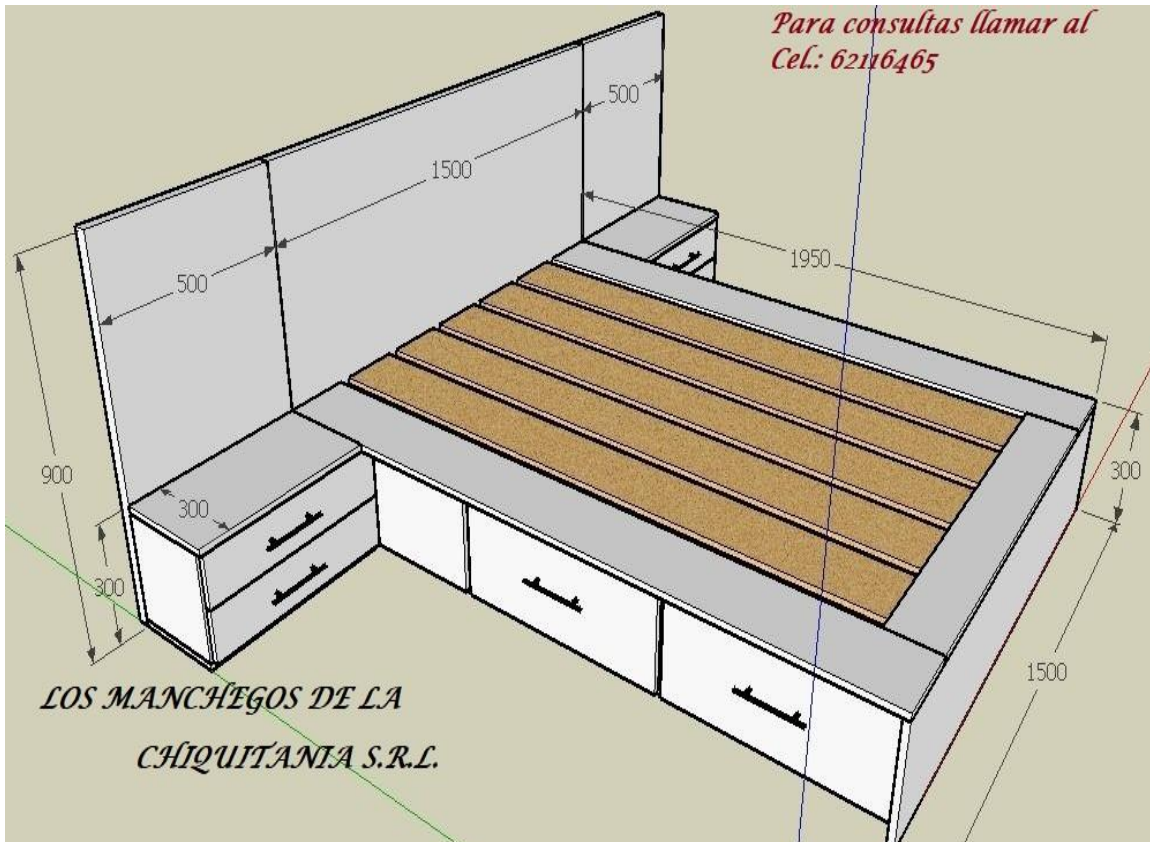







LOS MANCHEGOS Y LA CHIQUITANIA S.R.L.

*LOS MANCHEGOS  
DE LA  
CHIQUITANIA S.R.L.*



*Para consultas llamar  
al Cel.: 62116465*

*LOS MANCHEGOS  
DE LA  
CHIQUITANIA S.R.L.*

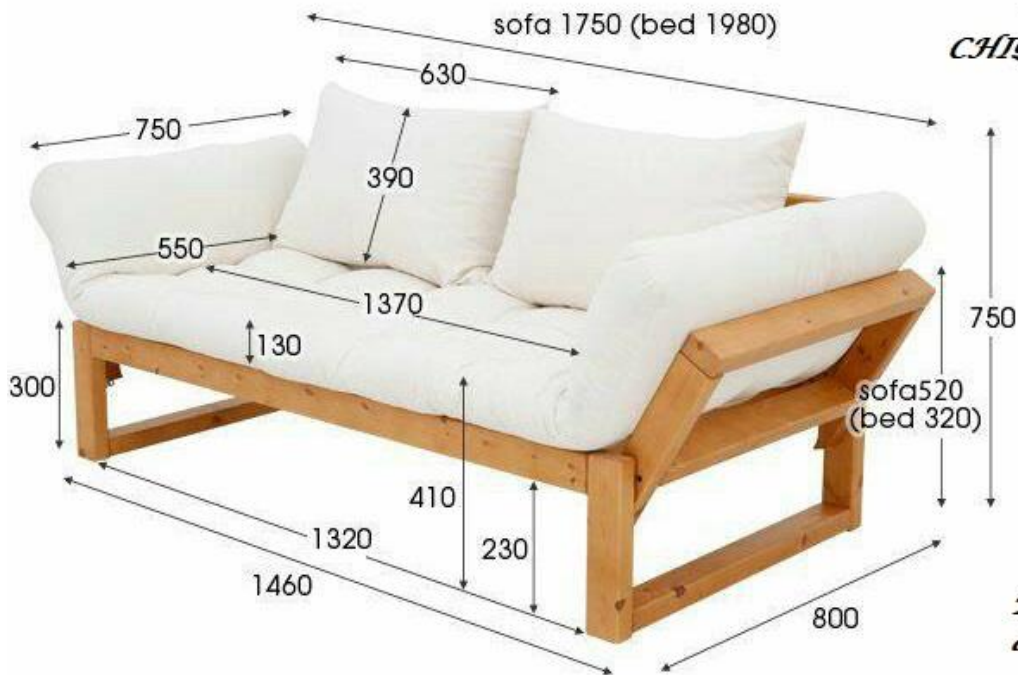

*Para consultas llamar  
al Cel.: 62116465*



*LOS MANCHEGOS  
DE LA  
CHIQUITANIA S.R.L.*



*Para consulta  
llamar  
al Cel.: 62116465*



*LOS MANCHEGOS  
DE LA  
CHIQUITANIA S.R.L.*

*Para consultas llamar  
al Cel.: 62116465*



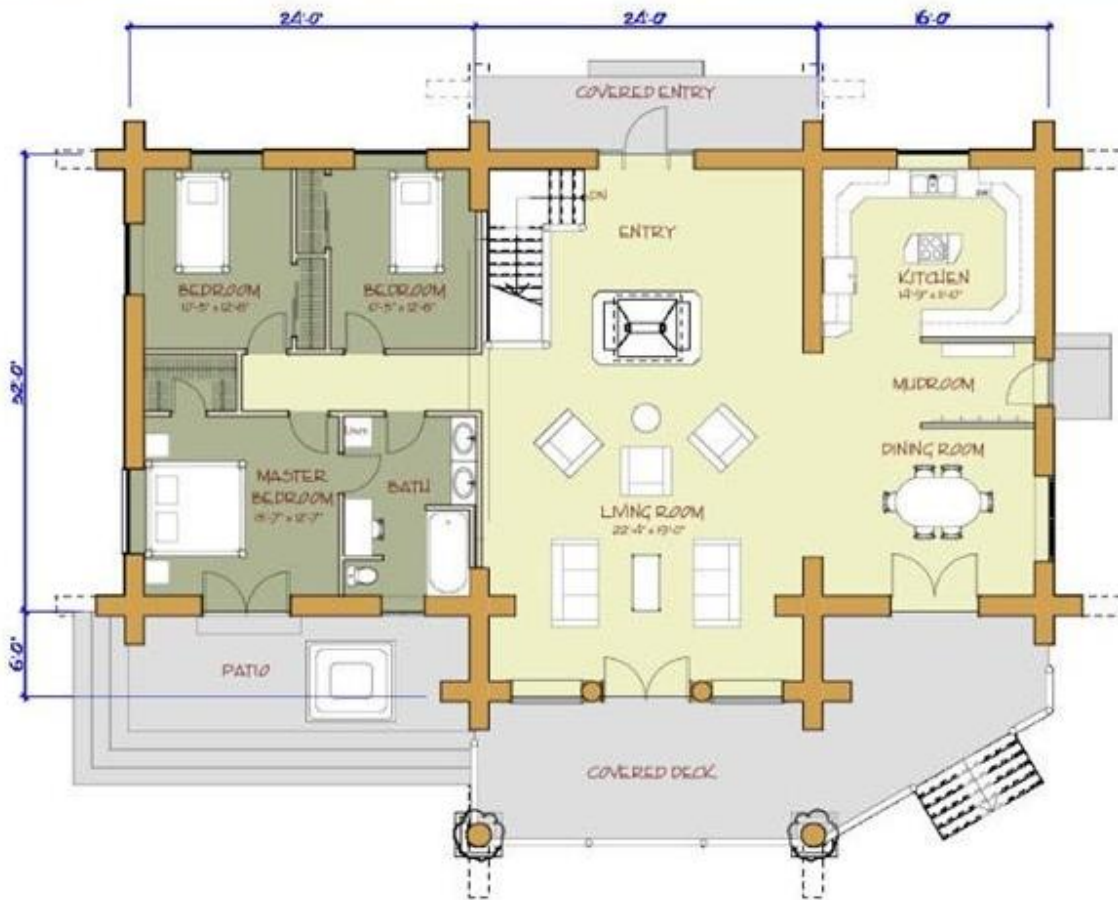



Planta 1°  
piso

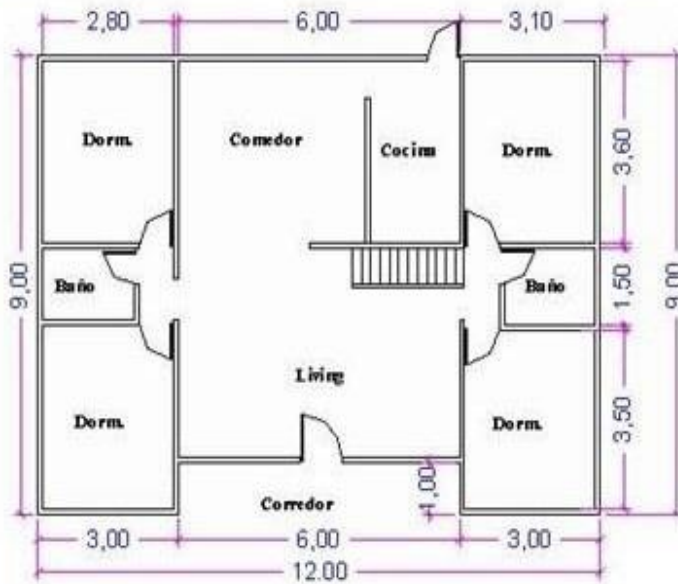

*LOS MANCHEGOS  
DE LA  
CHIQUITANIA S.R.L.*

Planta 2°  
piso

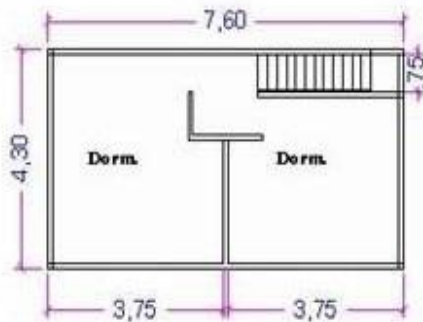

*Para consultas llamar al  
Cel.: 62116465*







*LOS MANCHEGOS  
DE LA  
CHIQUITANIA S.R.L.*



*Para consultas llamar  
al Cel.: 62116465*

**116 MT2**



*LOS MANCHEGOS DE LA  
CHIQUITANIA S.R.L.*

NM - 3160

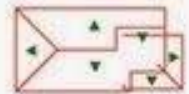

*Para consultas llamar al  
Cel.: 62116465*

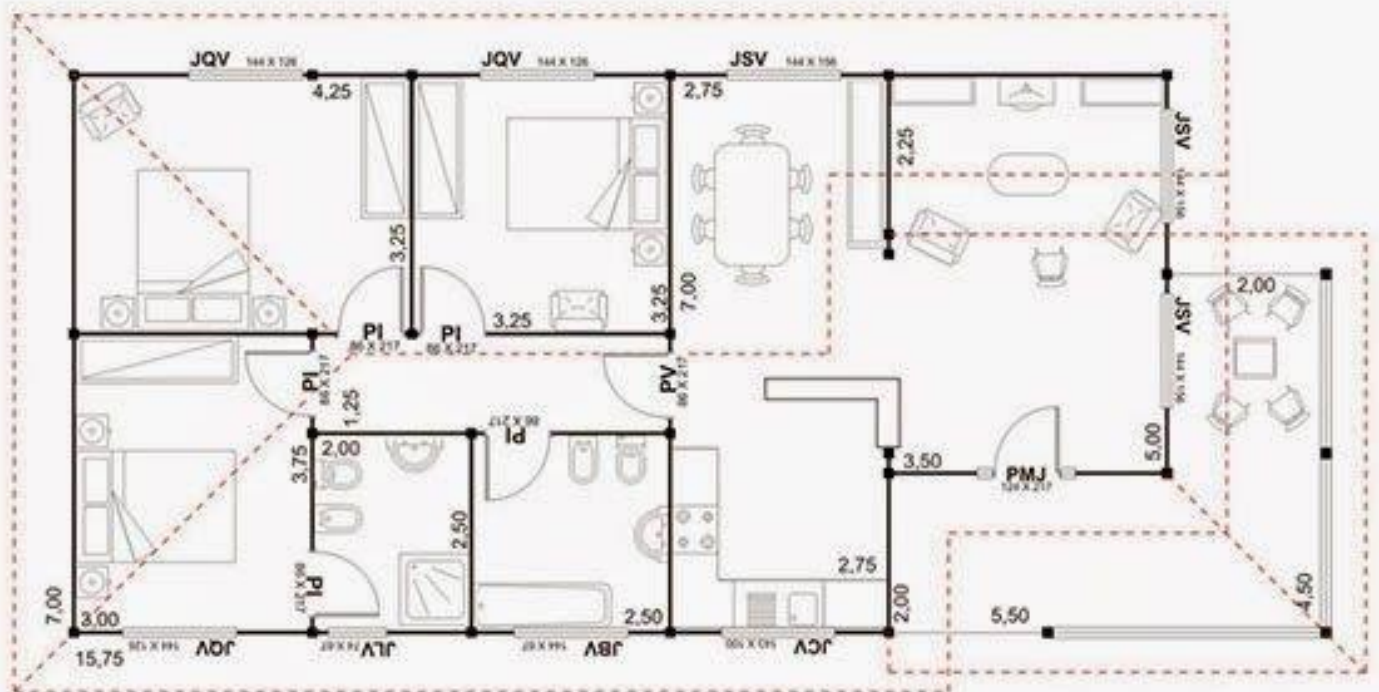



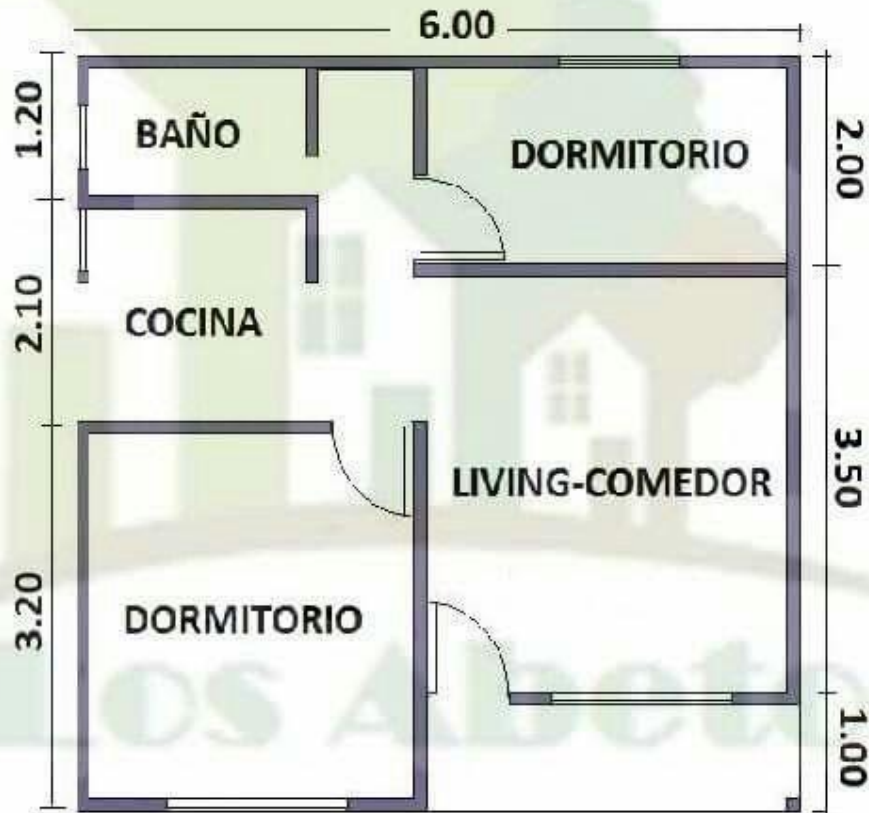

**36 MT<sup>2</sup>**





*LOS MANCHEGOS  
DE LA  
CHIQUITANIA S.R.L.*



*Para consultas llamar  
al Cel.: 62116465*

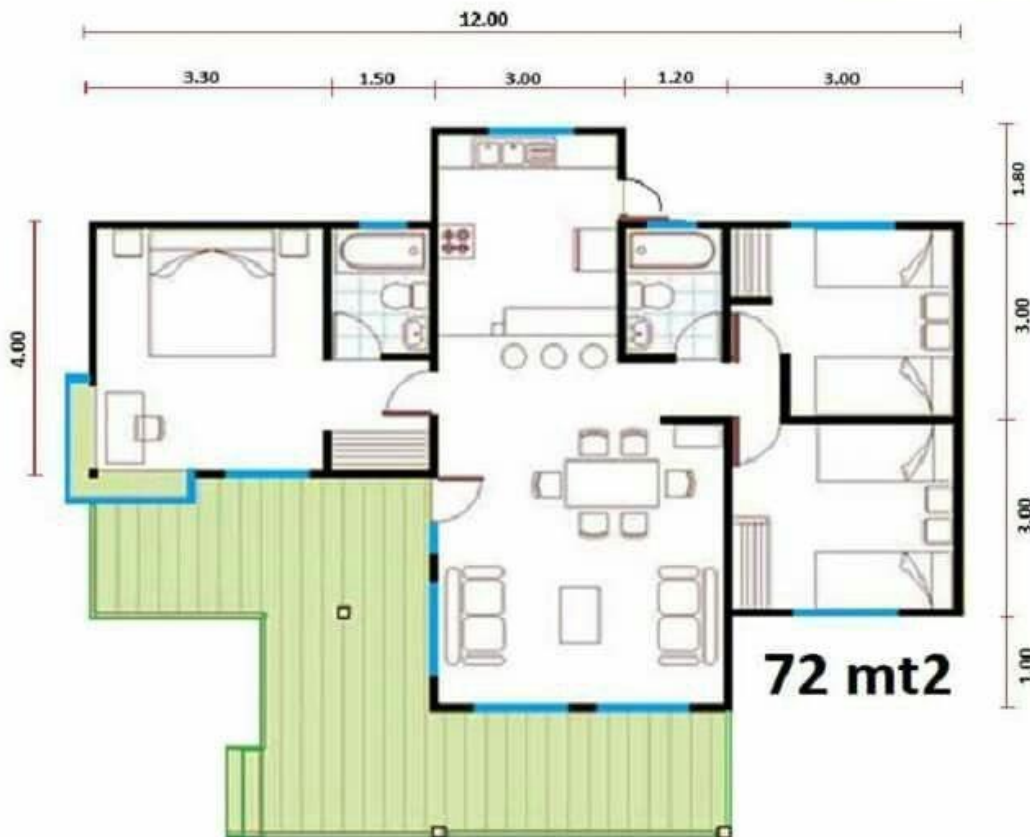

*LOS MANCHEGOS  
DE LA  
CHIQUITANIA S.R.L.*

*Para consultas llamar  
al Cel.: 62116465*





LOS MANCHEGOS Y LA CHIQUITANIA S.R.L.



*LOS MANCHEGOS  
DE LA  
CHIQUITANIA S.R.L.*



*Para consultas llamar  
al Cel.: 62116465*





*LOS MANCHEGOS  
DE LA  
CHIQUITANIA S.R.L.*

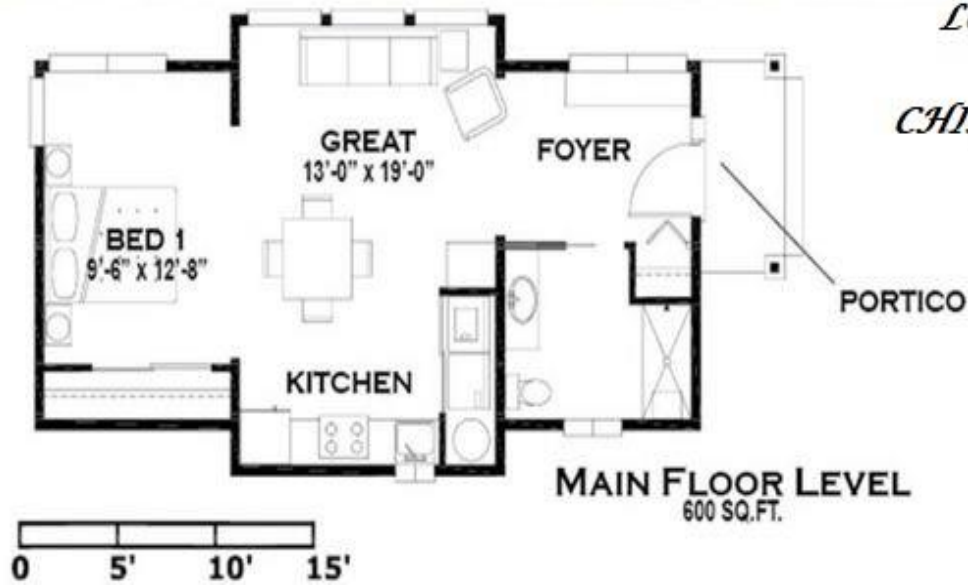

*Cel.: 62116465*



*LOS MANCHEGOS  
DE LA  
CHIQUITANIA S.R.L.*

*Para consultas llamar  
al Cel.: 62116465*